



Flexi Cot Teething Rail Fitting Instructions

munchproducts.com

Approx time: 5-10mins.
You will need: scissors, pen.
Flat surface such as a table.
Difficulty: Easy.

The Munch Flexi Cot Teething Rail is designed to fit one long side of a typical cot bed. Read the instructions carefully before installation. It can be cut to size with scissors (both length & width) to suit your particular cot make & model. The adhesive tape is easily removed when teething is finished.

1

Do not apply the adhesive tape until you have measured and cut the Munch Flexi. Do not use any other tape.



A

Measure the length of Munch Flexi against your cot rail. With a pen mark where to cut.

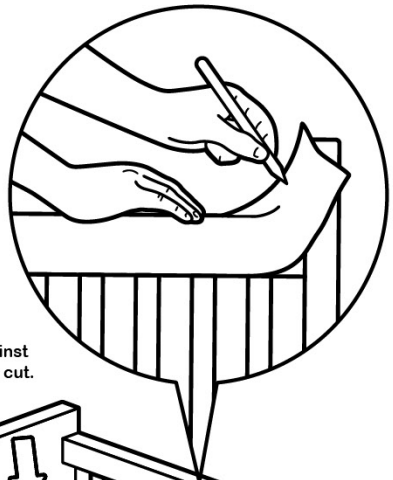

B

Cut Munch Flexi length with scissors.

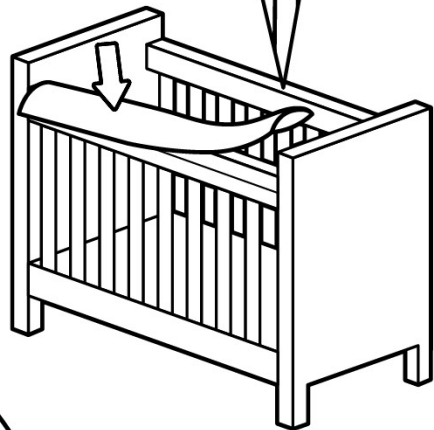
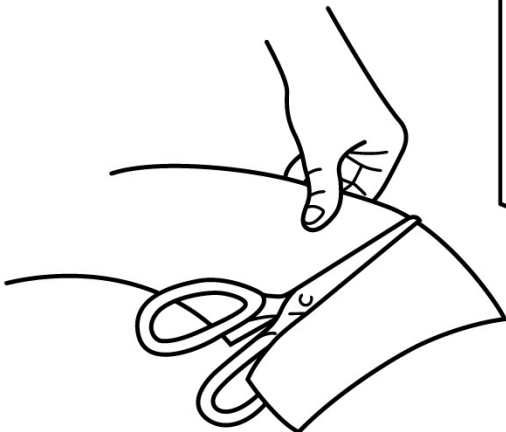

2

Measure the width of Munch Flexi against your cot rail. Align one edge of Munch Flexi along one bottom edge of your cot rail, hold firmly in place then fold Munch Flexi to snugly fit the shape of your cot rail.

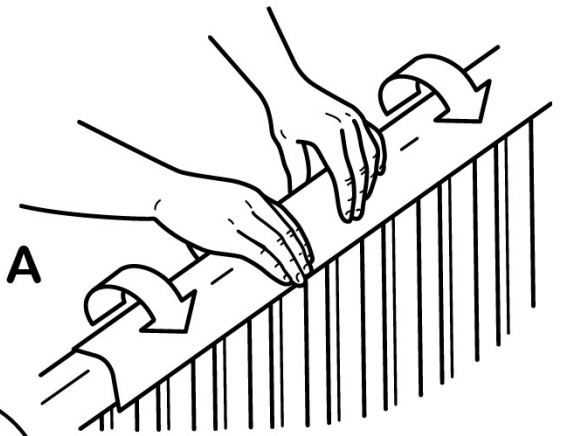

B

Cot rails with a width of around 5cm or less should have the Munch Flexi applied in a 'U' shape, protecting the inner, top and outer surfaces.

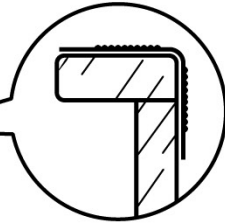
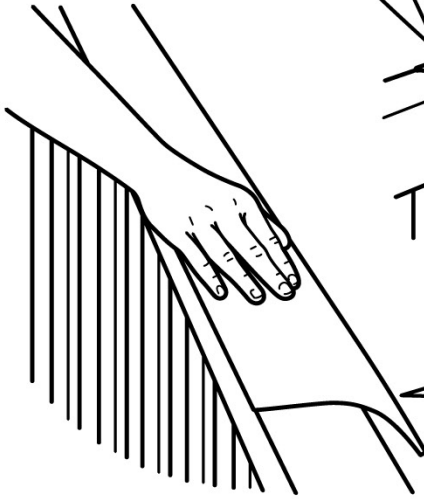
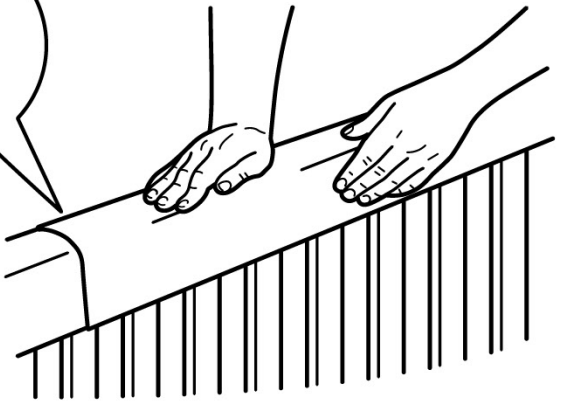

If your cot rail is wider than about 5cm the Munch Flexi should be applied in an 'L' shape, protecting the inner and top surfaces.

3

With a pen, mark where to cut Munch Flexi such that there is no overhang. For most cot profiles this will be the bottom edge of your cot rail.

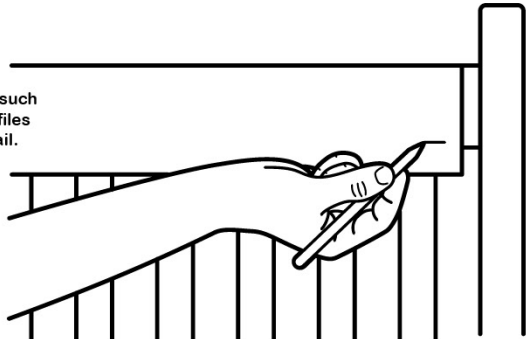

4

Cut Munch Flexi width to size.



5

Lay Munch Flexi on a flat surface, ridged side down, smooth side up.

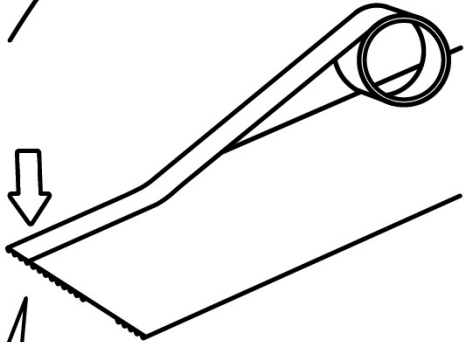

A

Apply the tape to the long edge, aligning the edge of the adhesive tape with the edge of Munch Flexi.

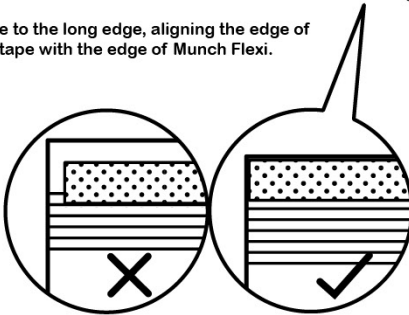

IMPORTANT: Eliminate any gap between the adhesive tape and the edge of the Munch Flexi so little fingers can't get a hold.

B

Repeat this step with the other long edge of the Munch Flexi

C

It is important to run your fingers firmly along both tape strips numerous times, applying pressure to secure a strong bond with the Munch Flexi before the red liner is removed.

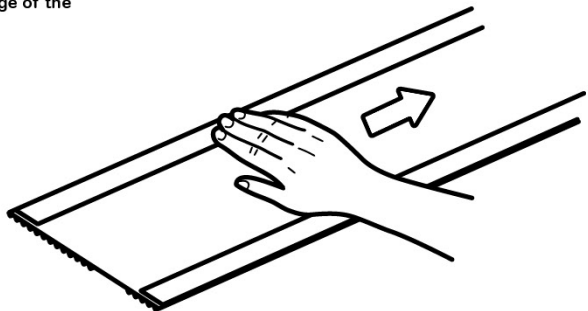

6

Peel away and remove both red liners, exposing the adhesive tape. Do not touch the adhesive tape and be careful to prevent it from coming into contact with anything other than the cot rail.

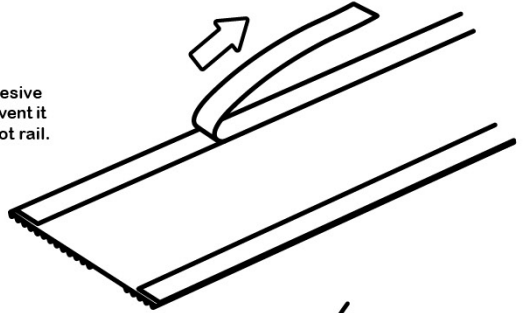

7

Lay the Munch Flexi on your cot rail, position it how you measured it. Apply pressure along both sides, starting from the middle and working outwards to the ends.

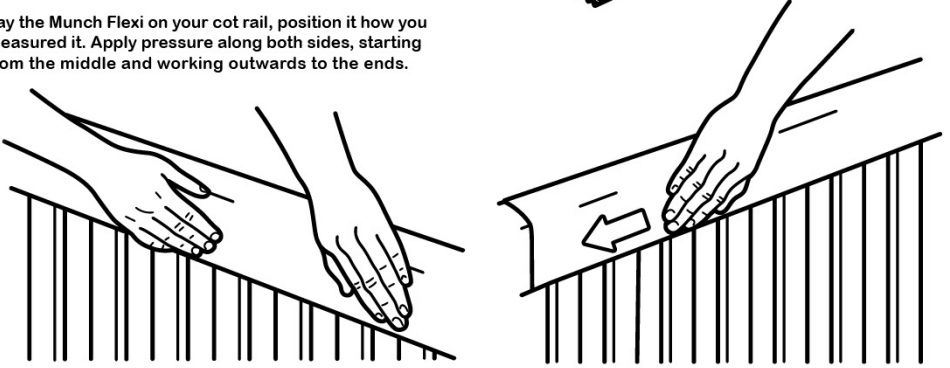

8

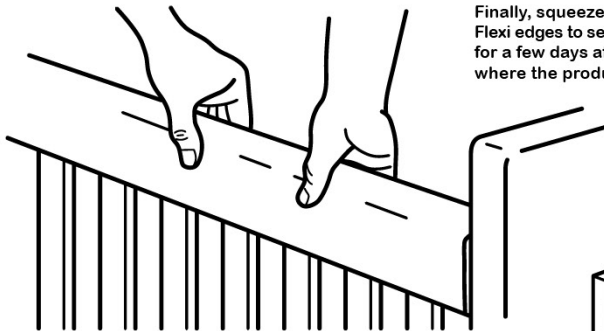

A

Finally, squeeze and apply pressure along both Munch Flexi edges to secure a strong bond. Repeat this regularly for a few days after installation, particularly at the sites where the product was folded inside the packaging.

B

When your baby has finished teething, simply peel away the Munch Flexi and the removable adhesive tape. Start by lifting up a corner of the Munch Flexi then gently peel away and remove it from the cot, leaving the adhesive tape attached to the cot rail. Gently loosen one end of the adhesive tape then slowly pull & stretch it, lengthwise, parallel to the cot rail, releasing the adhesive tape from the cot. Continue to slowly pull & stretch the adhesive tape, keeping your fingers close to the cot rail, until the entire adhesive strip is removed.

